

# PRICE LIST 2026

POUL KJÆRHOLM

US DOLLARS, EXCL. ALL TAXES / 01.2026

FRITZ HANSEN

# CONTENT

## 03 • GENERAL TERMS AND CONDITIONS

### CHAIRS

- 05 • PK3™
- 06 • PK8™
- 07 • PK9™
- 08 • PK11™
- 09 • PK15™

### LOUNGE AND SOFAS

- 10 • PK0 A™
- 11 • PK4™
- 12 • PK20™
- 13 • PK22™
- 14 • PK23™
- 15 • PK24™
- 16 • PK25™
- 17 • PK26™
- 18 • PK31™
- 19 • PK33™
- 20 • PK80™
- 21 • PK81™
- 22 • PK91™

### TABLES

- 23 • PK40™
- 24 • PK51™/PK55™
- 25 • PK54™/PK54A™
- 26 • PK58™
- 27 • PK60™
- 28 • PK61™/PK61A™
- 29 • PK62™
- 30 • PK63™/PK63A™
- 31 • PK65™
- 32 • PK71™

### MISCELLANEOUS

- 33 • PK111™

### SURFACE SELECTION

- 34 • Surface Selection

# GENERAL TERMS AND CONDITIONS

## CURRENCY & EFFECTIVE DATE

This price list is valid from 1 January 2026 and cancels all prior price lists.

Reservation is made for any errors and omissions. Furthermore, below general terms and conditions shall apply to all contracts under which Fritz Hansen A/S (Fritz Hansen) is the supplier/ sub-supplier.

## ORDERING

Orders must be placed through Fritz Hansen's web-based order system called the Partner Portal ([www.fritzhansen.com](http://www.fritzhansen.com) - professional). Orders are not binding until the customer has received a written order confirmation from Fritz Hansen.

Price lists state the recommended retail price (RRP) or prices excl. VAT exclusive of freight and fees. All prices can be changed without notice. Changes to the collection such as discontinued products and/or items out of stock can occur even when stated differently in the price list. Updated information will be available on the partner portal only.

## ORDER CANCELLATION

Orders can be cancelled in accordance with the below rules:

### STOCK ITEMS (Outdoor, Lighting, Accessories & Small Furniture):

	ORDERS CANCELLED WITHIN 24 HOURS AFTER ORDER CONFIRMATION HAS BEEN SENT
STANDARD PRODUCTS	FEE: NONE
SPECIALS OR MODIFIED PRODUCTS	FEE: FULL PRICE

Change and cancellation of order after 24 hours from receipt of the order confirmation is not possible.

### MTO (Furniture):

	ORDERS CANCELLED 0-3 DAYS AFTER ORDER CONFIRMATION HAS BEEN SENT	ORDERS CANCELLED 3-14 DAYS AFTER ORDER CONFIRMATION HAS BEEN SENT
STANDARD PRODUCTS	FEE: NONE	FEE: 5% OF NET PRICE EXCL. VAT.
SPECIALS OR MODIFIED PRODUCTS	FEE: FULL PRICE	

Change and cancellation of order after 14 days from receipt of the order confirmation is not possible.

## DELIVERY

The following freight rates apply:

RATE	PER ORDER
EU+UK+NO+CH+US*	DKK 200 / € 55 / £ 50 / SEK 600 / NOK 550 / USD 55 EXCL. VAT.
REST OF THE WORLD	TO BE PICKED UP AT FRITZ HANSEN WAREHOUSES

For markets EU+UK+NO+CH+US free freight offered according to the following rates: Free shipping from DKK 3.000 / € 400 / £ 350 / SEK 4.500 / NOK 4.000 / USD 500 total order value excl. VAT.

\* For deliveries to outer areas such as islands in Portugal and Spain as well as Svalbard in Norway and others, a surcharge of DKK 420 / € 56 / £ 42 / NOK 580 per parcel will apply.

## Standard delivery terms:

- Denmark: DDP delivery address (INCO-Terms 2020)
- Countries within the EU: DDP delivery address (INCO-Terms 2020)
- European countries outside the EU: DAP delivery address (INCO-Terms 2020)
- USA: DDP delivery address (INCO-Terms 2020)
- Canada:
  - Contract customers: DAP delivery address (INCO-Terms 2020)
  - Retail customers: DAT Montreal Terminal, EXW Horsens, DK
- Japan: DDP delivery address (INCO-Terms 2020)
- South Korea: DDP Fritz Hansen Busan (INCO-Terms 2020)
- Middle East, Asia, South and Central America, Australia: FCA Fritz Hansen warehouses in Denmark (INCO-Terms 2020)

## Special address deliveries:

- Delivery to non-standard warehouse with truck access and unloading ramp.
- Customer/Partner must confirm requirements are met.

Fee: DKK 1.100/€ 150/£ 130/SEK 1.600/NOK 1.700/USD 175 excl. VAT.

## White glove / Special deliveries:

- Direct delivery where export truck cannot access (lift or small truck required).

Fee: Case-by-case via Fritz Hansen's shipping department.

## Fix deliveries:

- Delivery on a fixed day to warehouse address.

Fee: DKK 1.100/€ 150/£ 130/SEK 1.600/NOK 1.700/USD 175 excl. VAT.

For FCA: The goods must be picked up at the Fritz Hansen warehouses no later than 30 calendar days after the confirmed shipping date of the consolidated order. Address(es) for pickup will be specified on the commercial invoice. If the goods are not picked up, Fritz Hansen will charge the customer DKK 24 / € 3 / USD 4 per day per colli (all furniture orders are colli based) or pallet (all Lighting, Accessories, and Skagerak Collection orders are pallet based).

## CLAIMS

The physical product must be inspected upon delivery. Damage incurred in transit as well as any defects and deficiencies on the product incurred as a result of transportation must be recorded on the POD upon delivery. Fritz Hansen must be notified in writing of any claims about product defects and deficiencies within 48 hours of delivery. If the claims are made in due time and with the acceptance of Fritz Hansen, the customer is entitled to demand a replacement delivery or to have the defect remedied. The customer cannot demand a reduction or a compensation. Claims/Replacements can only be made to the customer's address if delivery has not been made directly to the end user.

## MEASUREMENTS

The stated measurements act only as a guideline. The measurements can vary, and size difference on a product can occur.

## TERMS OF PAYMENT

Terms of payment are 30 days net cash from invoice date. Invoices are issued and dated when the goods are dispatched. In case of late payment, interest will be charged at a rate of 1.5 % for every month or part thereof as from the due date. Interest invoices are payable net cash within eight days. Fritz Hansen can decide that the customer shall pay in advance, if the customer's balance is or has previously been due, or if the order amount exceeds the credit limit approved by Fritz Hansen.

## OBSERVATION OF TITLE

Title to the goods shall not pass to the customer until Fritz Hansen (or any third party to whom Fritz Hansen has assigned its rights to the purchase price) has received the full purchase price and been reimbursed any expenses incurred.

## LIMITATION OF LIABILITY

Fritz Hansen will assume no liability for any loss as a result of delays, defects or any other breach of contract, unless such loss was caused by gross negligence on the part of Fritz Hansen. Fritz Hansen will assume no liability for any indirect loss, including loss of profits, operating loss, goodwill, loss of customers, running costs or any other consequential economic loss.

## CHOICE OF LAW AND JURISDICTION

Disputes between Fritz Hansen and its customers shall be subject to Danish law and shall be settled by Fritz Hansen's home court.

## FORCE MAJURE

Fritz Hansen is without liability for non-performance of Fritz Hansen's obligations in respect to any orders received, if such non-performance is due to circumstances out of Fritz Hansen's reasonable control, which prevent the fulfilment of the purchase agreement or makes the fulfilment unreasonably burdensome. As examples of such circumstances the following can be mentioned: Industrial dispute and other circumstances which are beyond the control of the parties, such as fire, war, mobilization or calling in for military service of similar extent, requisition, seizure, exchange controls, riots or disturbances, shortage of means of transportation, ordinary scarcity of goods, restrictions of motive power and defects in or late performance from sub-suppliers due to any of the aforementioned circumstances.

The above circumstances only lead to exemption from liability if their influence on the fulfilment of the purchase agreement could not be anticipated at the conclusion of the agreement. Fritz Hansen must without undue delay notify the customer in writing if any such circumstances, occurrence and cessation, if Fritz Hansen wishes to invoke any grounds of exemption from liability.

Regardless of what follows from these general conditions of sales and delivery, any party is entitled to terminate the purchase agreement by notifying the other party in writing, if the fulfilment of the agreement is prevented for more than 6 months due to one of the above circumstances.

Unless mandatory rules preclude this, Fritz Hansen is in no case liable to the customer for operating losses, lost earnings, or other financial consequential damages under these general conditions for sale and delivery.

## PRIVACY POLICY

At Fritz Hansen, confidentiality and data protection is a high priority. Guidelines for processing of personal data and description of the customer's and end users' rights according to applicable data protection law is governed by Fritz Hansen's privacy policy available on Fritz Hansen's website.

## WARRANTY

Fritz Hansen provides warranty on standard products against defects in materials and workmanship.

**Furniture and Outdoor:** The standard warranty is 5 years. For the Arne Jacobsen shell chairs (Ant™, Grand Prix™, Lily™, Series 7™), the standard warranty is 10 years. The China Chair™ has a standard warranty of 20 years. Within the Furniture collection, an extended warranty of up to 10 years is provided on selected products (see table below for details).

**Poul Kjærholm:** The standard warranty is 20 years except for PK0 A™, PK60™ and PK111™, which is 10 years, and PK3™, PK15™ and PK23™, which is 5 years. Wicker and French Cane have a warranty of 2 years.

**Lighting and Accessories & Small Furniture:** The standard warranty is 2 years. Within the Accessories & Small Furniture collection, an extended warranty of up to 5 years is provided on selected products. Specific for the Lighting collection: Transformers, ballasts, light sources, and other electronic devices are subject to the warranty terms of the manufacturer in question. Fritz Hansen does not cover costs related to installation and dismantling, replacement of ballasts/transformers and other similar costs related to electricians and the like.

The warranty on all collections does not extend to ordinary tear, wear or damage to upholstery. On any material, textile, or leather which is not listed in our price lists configured on a specific product, the standard warranty is 2 years. The warranty is void upon subsequent changes to the product. The warranty is valid from the date of delivery.

**ReNEW:** Refurbished chairs automatically come with a 10-year warranty from the date of delivery. All refurbished chairs are provided with a new label stating its originality and the year of refurbishment. Recrafted chairs automatically come with a 10-year warranty from the date of delivery.

Additional warranty conditions can be found on [www.fritzhansen.com](http://www.fritzhansen.com).

## RIGHT OF RETENTION

All items received by Fritz Hansen for repair, reupholstery, and/or processing remain the property of their legal owner, whether this is the Customer/Partner or the end customer. Fritz Hansen does not acquire ownership but is entitled to retain the items until full payment has been received for all work performed, materials supplied, and expenses incurred. This right of retention also applies in the event of the Customer/Partner's or the end customer's bankruptcy, reconstruction, liquidation, or any other inability to meet payment obligations and may be exercised against third parties, provided that the items were received with the consent of the owner or their authorised representative.

# WARRANTY OVERVIEW

Price list collections	Furniture collection						Poul Kjærholm collection				Outdoor collection	Lighting collection	Accessories & Small Furniture collection					
	Textile, Cushions	Leather (1)	Leather (2)	Bases (3)	Bases (4)	Movable parts (5)	Ant™, Grand Prix™, Lily™, Series 7™	ReNEW: Refurbish, Recrafted	Shells, Tabletops	Tabletops (6)	China Chair™	French Cane, Wicker	PK3™, PK15™, PK23™	PK0 A™, PK60™, PK111™	Poul Kjærholm Collection	Outdoor	Lighting	Accessories
2 years											x					x		
5 years	x	x		x		x			x			x			x			x*
10 years			x*		x*		x	x	x*				x					
20 years										x				x				

1. Leather: Soft and Essential
2. Leather: Aura, Haze, Natural, Grace and Embrace
3. Bases: Lacquered and Wooden (chairs), Powder coated (chairs and tables)
4. Bases: Aluminium, Chrome and Wooden (tables)
5. Moveable parts: Automatic return, Tilt, Height-adjustable, Swivel, Castors and Extension mechanism
6. Tabletops: Lacquer under tabletop, Lacquer on edges and Surface on tabletop

\*Find detailed overview on [www.fritzhansen.com/warranty](http://www.fritzhansen.com/warranty)



**PK3™**  
POUL KJÆRHOLM 1954

01.2026

Originally conceived in 1954, the PK3™ by Poul Kjærholm enters production for the first time. Crafted with two mirror-laminated veneer shells joined by a distinctive aluminium element, the chair rests on a steel base with architectural precision. Sculptural and stackable with an optional linking device, the PK3™ offers clarity, flexibility, and refined presence in both public and private settings.

MODEL	DESCRIPTION	BLACK COLOURED ASH	CLEAR LACQUERED ASH	CLEAR LACQUERED WALNUT
PK3	Chair, seat height 18.1", chromed or black powder coated tubular steel base	729	819	819

PK3

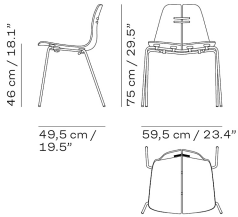



**PK8™**  
**POUL KJÆRHOLM 1978/2007**

01.2026

The PK8™ chair comes with a black or white shell front upholstered in a select range of leather types. The three-legged base is made of anodized satin brushed aluminum, while the shell is made of lacquered nylon plastic (PA).

MODEL	DESCRIPTION	CATEGORY 3	CATEGORY 4	CATEGORY 5
PK8	Chair, 17.3", anodised satin brushed aluminium legs	3,899	4,099	4,999

CATEGORY 3: Aura  
 CATEGORY 4: Haze  
 CATEGORY 5: Grace, Natural

PK8

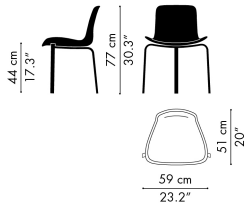



**PK9™**  
**POUL KJÆRHOLM 1960**

01.2026

The PK9™ is a fully upholstered chair in a select range of leather types. The three-legged base is made of satin brushed stainless spring steel. The inner shell is made of nylon.

MODEL	DESCRIPTION	CATEGORY 3	CATEGORY 4	CATEGORY 5
PK9	Chair, 16.9", satin brushed stainless spring steel legs	7,299	8,399	9,399

CATEGORY 3: Aura  
 CATEGORY 4: Haze  
 CATEGORY 5: Grace, Natural

**OPTIONS**

DESCRIPTION	PRICE
Glides	259

PK9

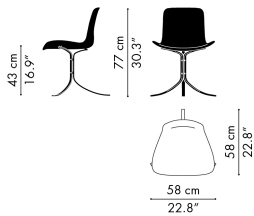

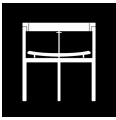

**PK11™**  
**POUL KJÆRHOLM 1957**

**01.2026**

The PK11™ armchair comes with armrests in clear lacquered ash and an upholstered seat in a select range of leather types. The base is made of satin brushed stainless steel.

MODEL	DESCRIPTION	CATEGORY 3	CATEGORY 4	CATEGORY 5
PK11	Armchair, 17.0-17.3", satin brushed stainless steel legs	4,699	5,399	6,099

CATEGORY 3: Aura  
 CATEGORY 4: Haze  
 CATEGORY 5: Grace, Natural

**PK11**

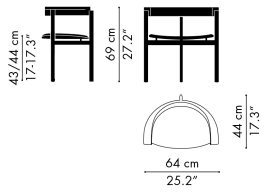



**PK15™**  
**POUL KJÆRHOLM 1979**

**01.2026**

Consisting of two materials, the PK15 is available in two configurations: clear lacquered ash or black colored ash, both with a natural French cane seat. An additional loose seat cushion in either black or natural leather is also available.

MODEL	DESCRIPTION	BLACK COLOURED ASH	CLEAR LACQUERED ASH
PK15	Chair, seat height 17.7", Wicker seat	3,899	4,299

MODEL	DESCRIPTION	CATEGORY 5
PK15CU	Seat cushion (loose)	749

CATEGORY 5 - SEE THE SURFACE SELECTION  
 Grace black or natural leather

**PK15** **PK15CU**

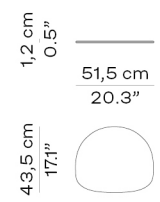
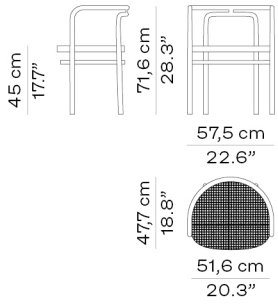



PKO A™  
POUL KJÆRHOLM 1952

01.2026

The PKO A™ lounge chair is made from two pressure molded veneer shells and is available in two different finishes: Clear lacquered Oregon Pine or black colored ash. Between the two shell parts are two cinnabar red spacers.

MODEL	DESCRIPTION	BLACK COLOURED ASH	OREGON PINE
PKO A	Lounge chair, pressure molded veneer	3,699	3,899

PKO A

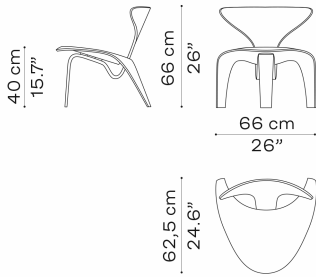

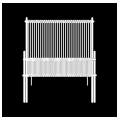

**PK4™**  
**POUL KJÆRHOLM 1952**

01.2026

The PK4™ lounge chair is made from stainless steel tubing and flag halyard in natural or black. The frame is available in brushed or black powder-coated steel. PK4™ is available in 3 configurations and with 3 optional cushions in either canvas or leather.

MODEL	DESCRIPTION	FLAG HALYARD	CANVAS	CATEGORY 5
PK4	PK4™ Lounge chair, brushed stainless or black powder coat	3,099		
PK4ST	PK4™ Lounge chair, brushed stainless or black powder coat, including cushion		3,399	3,599

FLAG HALYARD COLORS - SEE THE SURFACE SELECTION  
 NATURAL, BLACK

CANVAS COLORS - SEE THE SURFACE SELECTION

CATEGORY 5 - SEE THE SURFACE SELECTION  
 Grace black leather

PK4

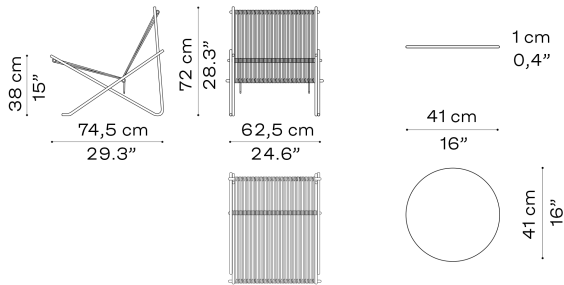



**PK20™**  
POUL KJÆRHOLM 1968

01.2026

The PK20™ lounge chair is available in a select range of leather types or wicker. The leather version also includes a matching leather headrest. The base is made of matt chromed spring steel.

MODEL	DESCRIPTION	WICKER	CATEGORY 3	CATEGORY 4	CATEGORY 5
PK20	Lounge chair, leather, leather headrest, matt chromed spring steel base		14,999	16,999	19,499
PK20	Lounge chair, wicker, matt chromed spring steel base	10,999	-		

CATEGORY 3: Aura  
CATEGORY 4: Haze  
CATEGORY 5: Grace, Natural

PK20

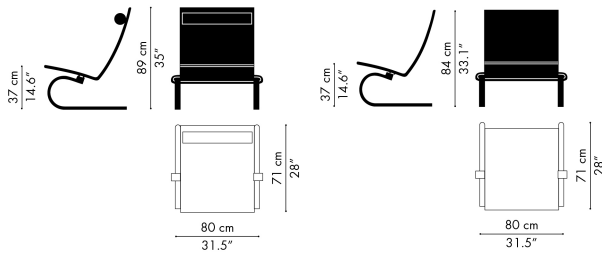



**PK22™**  
**POUL KJÆRHOLM 1956**

01.2026

The PK22™ lounge chair is available in wicker, canvas and a select range of leather types. The base is made of satin brushed stainless spring steel.

MODEL	DESCRIPTION	CANVAS	WICKER	CATEGORY 3	CATEGORY 4	CATEGORY 5
PK22	Lounge chair, satin brushed stainless spring steel base	4,399	4,999	5,899	6,899	7,899

CATEGORY 3: Aura  
 CATEGORY 4: Haze  
 CATEGORY 5: Grace, Natural

CANVAS COLORS - SEE THE SURFACE SELECTION  
 NATURAL, BLACK

PK22

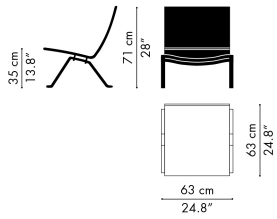



**PK23™**  
POUL KJÆRHOLM 1954

01.2026

The PK23™ chair is available in two versions: laminated veneer shells non-upholstered or with front upholstery for a softened expression and enhanced comfort. Both versions are available in black-painted ash, walnut, or oak veneer. A double bracket connector detail elegantly bridges the backrest divide. The base comes in stainless steel for all shell types, or in black powder-coated steel exclusively for the black-painted ash version.

MODEL	DESCRIPTION	BLACK COLOURED ASH	CLEAR LACQUERED OAK	CLEAR LACQUERED WALNUT
PK23	Lounge chair, base in brushed stainless steel - matt, or powder coated steel, black (only available with shell in black coloured ash)	1,399	1,499	1,499

**FRONT UPHOLSTERED - COLOURED VENEER**

MODEL	DESCRIPTION	CHRISTIANSHAVN	CATEGORY 1	CATEGORY 2	CATEGORY 3	CATEGORY 4	CATEGORY 5
PK23	Lounge chair, base in brushed stainless steel - matt, or powder coated steel, black (only available with shell in black coloured ash)	1,999	2,199	2,499	2,699	2,699	3,099

CATEGORY 1: Canvas, Remix, Re-Wool, Technicolor, Tonus  
 CATEGORY 2: Acca, Fiord, Steelcut, Steelcut Trio, Sunniva, Vanir  
 CATEGORY 3: Aura  
 CATEGORY 4: Haze  
 CATEGORY 5: Grace, Natural

- SEE THE SURFACE SELECTION  
 BLACK (195)

**FRONT UPHOLSTERED - CLEAR LACQUERED VENEER**

MODEL	DESCRIPTION	CHRISTIANSHAVN	CATEGORY 1	CATEGORY 2	CATEGORY 3	CATEGORY 4	CATEGORY 5
PK23	Lounge chair, base in brushed stainless steel - matt, or powder coated steel, black (only available with shell in black coloured ash)	2,099	2,299	2,599	2,799	2,799	3,199

CATEGORY 1: Canvas, Remix, Re-Wool, Technicolor, Tonus  
 CATEGORY 2: Acca, Fiord, Steelcut, Steelcut Trio, Sunniva, Vanir  
 CATEGORY 3: Aura  
 CATEGORY 4: Haze  
 CATEGORY 5: Grace, Natural

CLEAR LACQUERED VENEER: - SEE THE SURFACE SELECTION

**PK23**

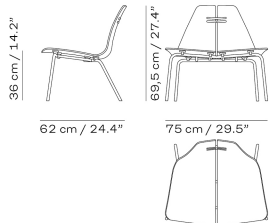



**PK24™**  
**POUL KJÆRHOLM 1965**

The PK24™ chaise longue is available in a select range of leather types or wicker. Both versions include a leather headrest. The base is made of satin brushed stainless spring steel.

MODEL	DESCRIPTION	CATEGORY 3	CATEGORY 4	CATEGORY 5
PK24	Chaise longue, wicker, leather headrest, satin brushed stainless spring steel base	22,999	23,499	23,499
PK24	Chaise longue, leather, leather headrest, satin brushed stainless spring steel base	22,999	25,499	29,999

CATEGORY 3: Aura  
 CATEGORY 4: Haze  
 CATEGORY 5: Grace, Natural

PK24

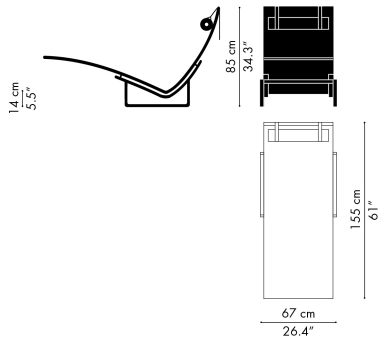



**PK25™**  
**POUL KJÆRHOLM 1951**

**01.2026**

The PK25™ lounge chair is available in flag halyard, in natural or black. The base is made of matt chromed spring steel.

MODEL	DESCRIPTION	FLAG HALYARD
PK25	Lounge chair, matt chromed spring steel base	14,999

FLAG HALYARD COLORS - SEE THE SURFACE SELECTION  
NATURAL, BLACK

**PK25**

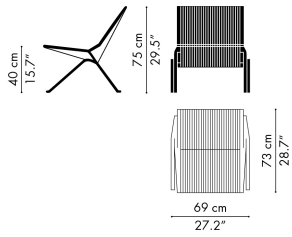



**PK26™**  
**POUL KJÆRHOLM 1956**

**01.2026**

The PK26™ is a wall-mounted modular sofa. The frame is made in matt chromed spring steel, and the cushion core is made of hairlock (natural fibers and latex). The sofa is upholstered in a select range of leather types and an exclusive leather type called Niger leather (special trading terms apply).

MODEL	DESCRIPTION	CATEGORY 3	CATEGORY 4	CATEGORY 5
PK26	1-seater sofa, wall-mounted, matt chromed spring steel frame	22,999	26,999	31,499
PK26	2-seater sofa, wall-mounted, matt chromed spring steel frame	45,999	53,499	62,999

CATEGORY 3: Aura  
 CATEGORY 4: Haze  
 CATEGORY 5: Grace, Natural

PK26-1

PK26-2

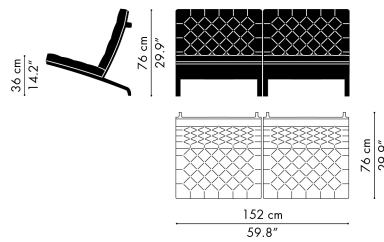
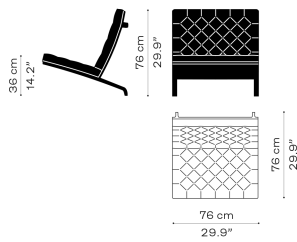





**PK33™**  
**POUL KJÆRHOLM 1959**

01.2026

The PK33™ stool is available with a detachable cushion in a select range of leather types or canvas. The three-legged stool has a matt chromed spring steel base.

MODEL	DESCRIPTION	CANVAS	CATEGORY 3	CATEGORY 4	CATEGORY 5
PK33	Stool, matt chromed spring steel base	3,599	4,299	4,899	5,499

CATEGORY 3: Aura  
 CATEGORY 4: Haze  
 CATEGORY 5: Grace, Natural

CANVAS COLORS - SEE THE SURFACE SELECTION  
 NATURAL

PK33

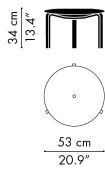

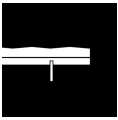

**PK80™**  
**POUL KJÆRHOLM 1957**

01.2026

The PK80™ daybed comes with a cushion upholstered in a limited range of leather types as well as in canvas. It rests on a painted plywood bedplate, and the cushion core is made of granulated foam and hairlok (natural fibres and latex). The base is made of satin brushed stainless steel.

MODEL	DESCRIPTION	CANVAS	CATEGORY 3	CATEGORY 4	CATEGORY 5
PK80	Daybed, satin brushed stainless steel base	17,499	22,499	25,999	29,499

CATEGORY 3: Aura  
 CATEGORY 4: Haze  
 CATEGORY 5: Grace, Natural

CANVAS COLORS - SEE THE SURFACE SELECTION  
 NATURAL

**PK80**

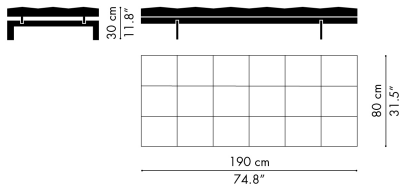

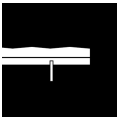

**PK81™**  
**POUL KJÆRHOLM 1959**

The PK81™ daybed is a square version of the classic daybed PK80™. The base is made of satin brushed stainless steel and the daybed rests on a painted plywood bedplate. The cushion core is made of granulated foam and hairlok (natural fibres and latex) and comes upholstered in a select range of leather types as well as in an exclusive leather type called Buffalo leather (special trading terms apply).

MODEL	DESCRIPTION	CATEGORY 3	CATEGORY 4	CATEGORY 5
PK81	Daybed, satin brushed stainless steel base	31,499	36,499	42,999

CATEGORY 3: Aura  
 CATEGORY 4: Haze  
 CATEGORY 5: Grace, Natural

**PK81**

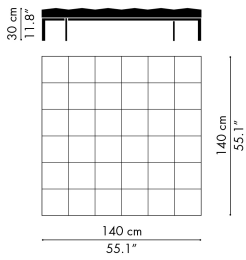



**PK91™**  
**POUL KJÆRHOLM 1961**

**01.2026**

The PK91™ folding stool is available with a seat in a select range of leather types as well as in canvas. The base is made of satin brushed stainless steel.

MODEL	DESCRIPTION	CANVAS	CATEGORY 3	CATEGORY 4	CATEGORY 5
PK91	Folding stool, satin brushed stainless steel base	4,799	5,099	5,899	6,299

CATEGORY 3: Aura  
CATEGORY 4: Haze  
CATEGORY 5: Grace, Natural

CANVAS COLORS - SEE THE SURFACE SELECTION  
NATURAL, BLACK

**PK91**

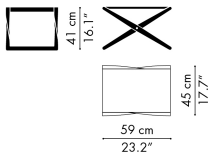



**PK40™**  
**POUL KJÆRHOLM 1980**

01.2026

The PK40™ table comes with an upholstered tabletop in a select range of leather types. The base is made in satin brushed stainless steel.

MODEL	DESCRIPTION	CATEGORY 3	CATEGORY 4	CATEGORY 5	H/L/W
PK40	Table, satin brushed stainless steel base	21,999	25,999	37,999	27.6/55.1/55.1

CATEGORY 3: Aura  
CATEGORY 4: Haze  
CATEGORY 5: Grace, Natural

PK40

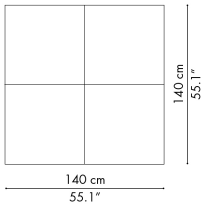
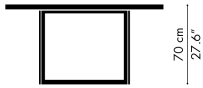



**PK51™/PK55™**  
**POUL KJÆRHOLM 1957**

01.2026

The PK51™ and PK55™ tables come with a tabletop in clear lacquered ash veneer. The bases are made of satin brushed stainless steel.

MODEL	DESCRIPTION	ASH	H/L/W
PK51	Table, satin brushed stainless steel base	13,499	28.3/80.3/40.2
PK55	Table, satin brushed stainless steel base	10,499	28.3/70.9/35.4

PK51

PK55

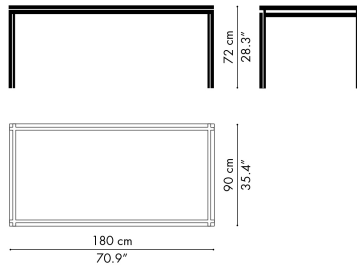
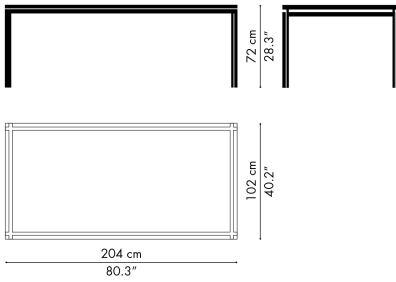



**PK54™/PK54A™**  
**POUL KJÆRHOLM 1963**

01.2026

The PK54™ table is available with a tabletop in marble or granite. The square base is made of satin brushed stainless steel. The circular table top has an optional expansion ring consisting of six sections including a storage rack, both made of natural, untreated solid maple.

MODEL	DESCRIPTION	GRANITE	MARBLE	H/Ø
PK54	Table, satin brushed stainless steel base	14,999	15,999	27.2/55.1

**MARBLE COLORS - SEE THE SURFACE SELECTION**  
 WHITE (HONED & ROLLED), GREY-WHITE (ROLLED), BEIGE (HONED), GREY-BROWN (HONED) AND BLACK (HONED)

**GRANIT - SEE THE SURFACE SELECTION**  
 DARK AND GREY-WHITE

**NOTE**  
 THE MARBLE TABLETOPS ARE ALL UNIQUE WITH THEIR OWN PATTERN.

**EXPANSION RING**

MODEL	DESCRIPTION	SOLID MAPLE	
PK54A	Expansion ring, 6 sections, untreated solid maple, incl. storage rack	16,499	ø82.7

PK54

PK54 + PK54A

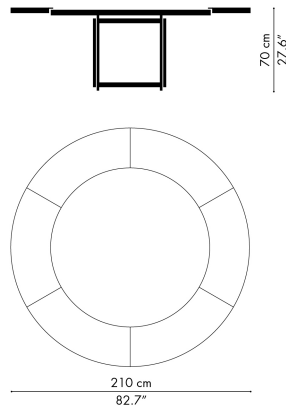
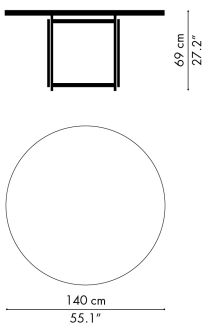



**PK58™**  
POUL KJÆRHOLM 1963/2007

01.2026

The PK58™ table comes with a white polyester composite tabletop. The square base is made of anodized satin brushed aluminum.

MODEL	DESCRIPTION	WHITE	H/Ø
PK58	Table, anodised satin brushed aluminium base	7,899	28/51.2

PK58

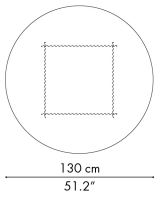
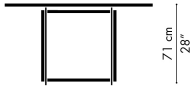



**PK60™**  
**POUL KJÆRHOLM 1952**

**01.2026**

The PK60™ coffee table comes with a circular tempered glass tabletop and a three-legged base in pressure molded veneer. The base is available in two different finishes: Clear lacquered Oregon Pine or black colored ash.

MODEL	DESCRIPTION	BLACK COLOURED ASH	OREGON PINE	H/Ø
PK60	Coffee table, pressure molded veneer base	4,199	4,599	17.3/41.4

**PK60**

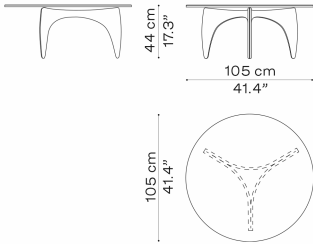



**PK61™/PK61A™**  
**POUL KJÆRHOLM 1956**

01.2026

The PK61™ coffee table is available with different tabletops; slate, marble, granite and glass. PK61A™ is an enlarged version of PK61™ and is available with tabletops in marble, granite and glass. The base for both tables is made of satin brushed stainless steel.

MODEL	DESCRIPTION	GLASS	GRANITE	SLATE	MARBLE	H/L/W
PK61	Coffee table, satin brushed stainless steel base	5,099	5,699	5,999	5,999	12.6/31.5/31.5
PK61A	Coffee table, satin brushed stainless steel base	8,299	9,699		9,699	12.6/47.2/47.2

**MARBLE COLORS - SEE THE SURFACE SELECTION**  
 WHITE (HONED & ROLLED), GREY-WHITE (ROLLED), BEIGE (HONED), GREY-BROWN (HONED) AND BLACK (HONED)

**GRANIT - SEE THE SURFACE SELECTION**  
 DARK & GREY-WHITE

**NOTE**  
 THE MARBLE TABLETOPS ARE ALL UNIQUE WITH THEIR OWN PATTERN.

**PK61**

**PK61A**

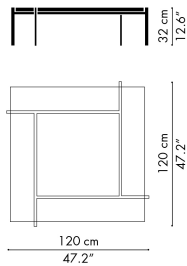
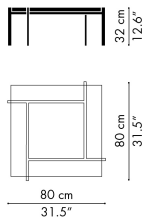

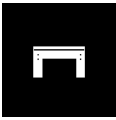

**PK62™**  
**POUL KJÆRHOLM 1968**

01.2026

The PK62™ side table is available with a tabletop in slate, marble or granite. The base is made of satin brushed stainless steel.

MODEL	DESCRIPTION	SLATE	MARBLE	GRANITE	H/L/W
PK62	Side table, satin brushed stainless steel	3,399	3,399	3,399	6.7/31.5/10.6

- SEE THE SURFACE SELECTION  
 WHITE (HONED & ROLLED), GREY-WHITE (ROLLED), BEIGE (HONED), GREY-BROWN (HONED) AND BLACK (HONED)

GRANIT - SEE THE SURFACE SELECTION  
 DARK

NOTE  
 THE MARBLE TABLETOPS ARE ALL UNIQUE WITH THEIR OWN PATTERN.

PK62

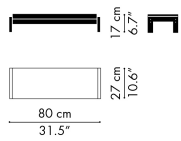



**PK63™/PK63A™**  
**POUL KJÆRHOLM 1968**

**01.2026**

The PK63™ and PK63A™ coffee tables are available with a tabletop in slate, marble or granite. The base is made of satin brushed stainless steel.

MODEL	DESCRIPTION	SLATE	MARBLE	GRANITE	H/L/W
PK63	Coffee table, satin brushed stainless steel base	7,499	7,499	7,499	12.2/70.9/23.6
PK63A	Coffee table, satin brushed stainless steel base	6,099	6,099	6,099	12.2/47.2/23.6

- SEE THE SURFACE SELECTION  
 WHITE (HONED & ROLLED), GREY-WHITE (ROLLED), BEIGE (HONED), GREY-BROWN (HONED) AND BLACK (HONED)

**GRANIT** - SEE THE SURFACE SELECTION  
 DARK

**NOTE**  
 THE MARBLE TABLETOPS ARE ALL UNIQUE WITH THEIR OWN PATTERN.

**PK63**

**PK63A**

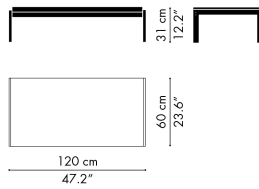
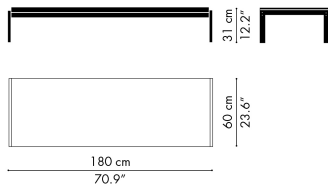



**PK65™**  
**POUL KJÆRHOLM 1979**

01.2026

The PK65™ coffee table is available with a tabletop in; slate, marble, granite and glass. The base is made of satin brushed stainless steel.

MODEL	DESCRIPTION	GLASS	SLATE	MARBLE	GRANITE	H/L/W
PK65	Coffee table, satin brushed stainless steel base	7,099	7,499	7,499	7,499	15/39.4/39.4

- SEE THE SURFACE SELECTION  
 WHITE (HONED & ROLLED), GREY-WHITE (ROLLED), BEIGE (HONED), GREY-BROWN (HONED) AND BLACK (HONED)

GRANIT - SEE THE SURFACE SELECTION  
 DARK  
 NOTE  
 THE MARBLE TABLETOPS ARE ALL UNIQUE WITH THEIR OWN PATTERN.

**PK65**

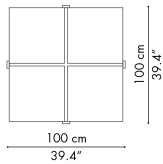

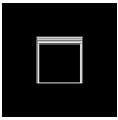

**PK71™**  
**POUL KJÆRHOLM 1957**

01.2026

The PK71™ nesting table consists of three tables with a white or black acrylic tabletop. The bases are made of satin brushed stainless steel.

MODEL	DESCRIPTION	WHITE, BLACK	H/L/W
PK71	Nesting table, 3 sizes, satin brushed stainless steel base	3,199	11.22/11/11

**PK71**

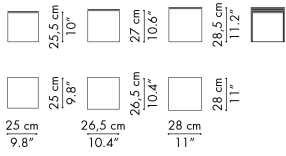

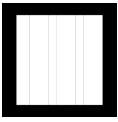

**PK111™**  
**POUL KJÆRHOLM 1956**

01.2026

Elegant and flexible room divider consisting of 6 modules in clear lacquered Oregon Pine veneer. The modules can be easily expanded to achieve the desired size.

MODEL	DESCRIPTION	OREGON PINE
PK111	6 panel room divider in clear lacquered veneer	6,899

**PK111**

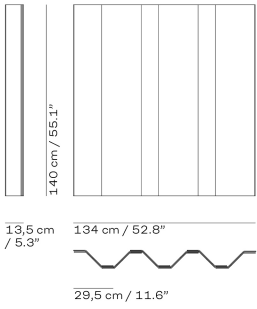

# SURFACE SELECTION

- 35 • Leather
- 36 • Wood
- 37 • Acrylic
  - Polyester Composite
  - Marble
  - Granite
  - Slate
  - Glass
- 38 • Metal
  - Flag Halyard
  - Canvas
  - Wicker
  - French Cane

# SURFACE SELECTION

Colours and materials may vary from the images shown.  
Actual colour, gloss level and structure may vary.

## LEATHER

Please note that leather is a natural material with natural variation in colour and surface structure. The presence of scars and marks from bites etc. on the leather may occur and are characteristics of genuine leather.

### AURA



BLACK

BLACK BROWN

COGNAC

WALNUT

BEIGE

PK8™  
PK9™  
PK11™  
PK20™  
PK22™  
PK23™  
PK24™  
PK26™  
PK31™  
PK33™  
PK40™  
PK80™  
PK81™  
PK91™

**CATEGORY: 3**  
Chrome-tanned, top-coated, strong full-grain and durable surface. Fast to light.  
  
Thickness 1.4-1.6 mm.

### HAZE



ANTRACIT

DARK BROWN

WALNUT

BEIGE

PK8™  
PK9™  
PK11™  
PK20™  
PK22™  
PK23™  
PK24™  
PK26™  
PK31™  
PK33™  
PK40™  
PK80™  
PK81™  
PK91™

**CATEGORY: 4**  
Chrome-tanned, aniline, top grain leather. Smooth and velvety soft surface with natural markings and colour variations. Over time, the leather will patinate and become smoother and shinier in use.  
  
Thickness 1.0-1.4 mm.

### NATURAL



NATURAL

PK8™  
PK9™  
PK11™  
PK15™ (Seat cushion)  
PK20™  
PK22™  
PK23™  
PK24™  
PK26™  
PK31™  
PK33™  
PK40™  
PK80™  
PK81™  
PK91™

**CATEGORY: 5**  
Vegetable-tanned, chrome-free, natural leather, no colour or protective finish. Becomes darker and patinated with use, visible natural markings.  
  
Thickness 1.2-1.4 mm.

### GRACE

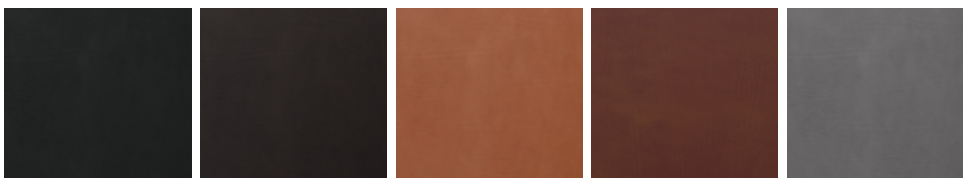

BLACK

DARK BROWN

WALNUT

CHESTNUT

CONCRETE GREY

PK4™ (Seat cushion)  
PK8™  
PK9™  
PK11™  
PK15™ (Seat cushion)  
PK20™  
PK22™  
PK23™  
PK24™  
PK26™  
PK31™  
PK33™  
PK40™  
PK80™  
PK81™  
PK91™

**CATEGORY: 5**  
Vegetable and chrome-tanned, aniline, full-grain with light structure and light impregnation. Becomes lighter and patinated with use, visible natural markings.  
  
Thickness 1.2-1.4 mm.

# SURFACE SELECTION

Colours and materials may vary from the images shown.  
Actual colour, gloss level and structure may vary.

## CLEAR LACQUERED VENEER



ASH

PK51™  
PK55™

OREGON PINE

PK0 A™  
PK60™  
PK111™

OAK

PK3™  
PK23™

WALNUT

PK3™  
PK23™

## COLOURED VENEER

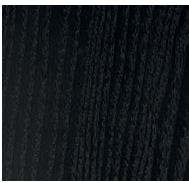

ASH - BLACK

PK0 A™  
PK3™  
PK23™  
PK60™

## CLEAR LACQUERED SOLID WOOD



ASH

PK11™  
PK15™

## UNTREATED SOLID WOOD



MAPLE

PK54A™ (Expansion ring)

## COLOURED SOLID WOOD



ASH - BLACK

PK15™

# SURFACE SELECTION

Colours and materials may vary from the images shown.  
Actual colour, gloss level and structure may vary.

## ACRYLIC

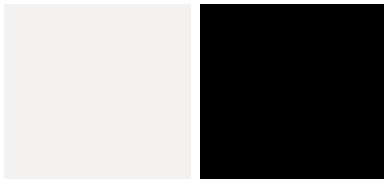

WHITE  
PK71™

BLACK  
PK71™

## POLYESTER COMPOSITE

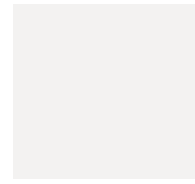

WHITE  
PK58™

## HONED MARBLE

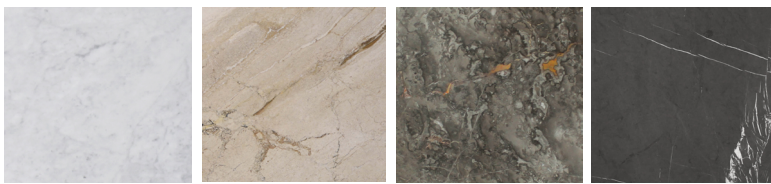

WHITE

PK54™  
PK61™  
PK61A™  
PK62™  
PK63™  
PK63A™  
PK65™

BEIGE

PK54™  
PK61™  
PK61A™  
PK62™  
PK63™  
PK63A™  
PK65™

GREY-BROWN

PK54™  
PK61™  
PK61A™  
PK62™  
PK63™  
PK63A™  
PK65™

BLACK

PK54™  
PK61™  
PK61A™  
PK62™  
PK63™  
PK63A™  
PK65™

## ROLLED MARBLE

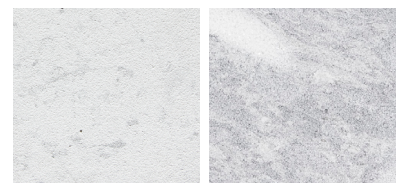

WHITE

PK54™  
PK61™  
PK61A™  
PK62™  
PK63™  
PK63A™  
PK65™

GREY-WHITE

PK54™  
PK61™  
PK61A™  
PK62™  
PK63™  
PK63A™  
PK65™

## GRANITE

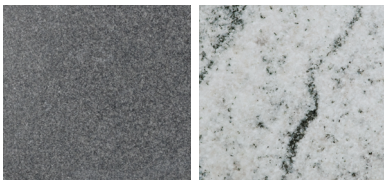

DARK

PK54™  
PK61™  
PK61A™  
PK62™  
PK63™  
PK63A™  
PK65™

GREY-WHITE

PK54™  
PK61™

## SLATE

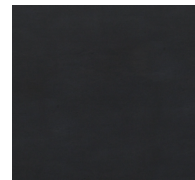

BLACK

PK61™  
PK62™  
PK63™  
PK63A™  
PK65™

## GLASS



CLEAR

PK60™

FLOAT

PK61™  
PK61A™  
PK65™

# SURFACE SELECTION

Colours and materials may vary from the images shown.  
Actual colour, gloss level and structure may vary.

## STEEL

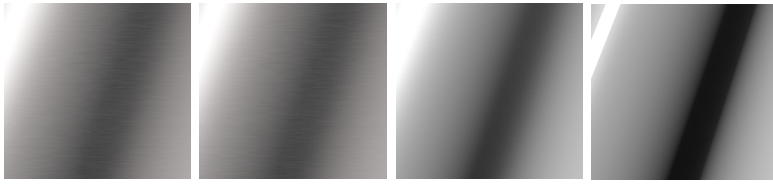

**BRUSHED SPRING  
STEEL - MATT**

PK9™  
PK11™  
PK22™  
PK24™  
PK40™  
PK51™  
PK54™  
PK55™  
PK61™  
PK61A™  
PK62™  
PK63™  
PK63A™  
PK65™  
PK71™  
PK80™  
PK81™  
PK91™

**BRUSHED STAINLESS  
STEEL - MATT**

PK3™  
PK4™  
PK23™

**CHROMED SPRING  
STEEL - MATT**

PK20™  
PK25™  
PK26™  
PK31™  
PK33™

**CHROMED STEEL  
- BRIGHT**

## POWDER COATED STEEL



**BLACK**

PK3™  
PK4™  
PK23™

## FLAG HALYARD



**NATURAL**  
100% FLAX WITH  
POLYESTER CORE

PK4™  
PK25™

**BLACK**  
100% FLAX WITH  
POLYESTER CORE

PK4™  
PK25™

## CANVAS

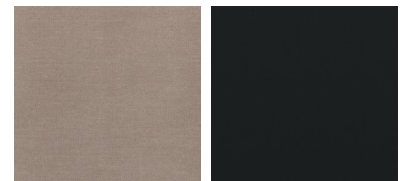

**NATURAL**  
100% COTTON

PK4™ (Seat cushion)  
PK22™  
PK33™  
PK80™  
PK91™

**BLACK**  
100% COTTON

PK4™ (Seat cushion)  
PK22™  
PK91™

## WICKER



**NATURAL**  
THICKNESS APPROX.  
2.5 MM AND 4.0 MM

PK20™  
PK22™  
PK24™

## FRENCH CANE

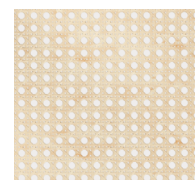

**NATURAL**

PK15™